

3D METAL MODEL KITS

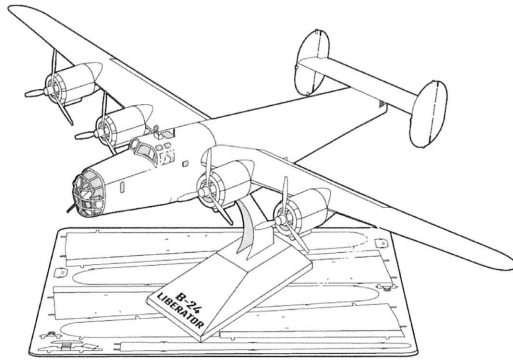

B-24 Liberator



Metal sheets

Same color parts on the right are duplicates

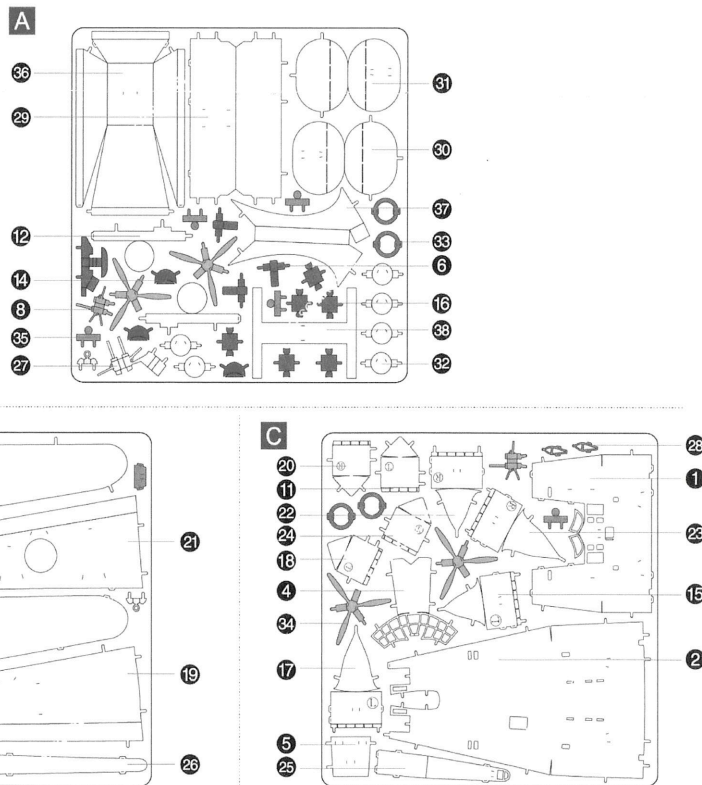

In order to avoid possible injury from sharp edges, please carefully discard the metal sheets after parts have been removed

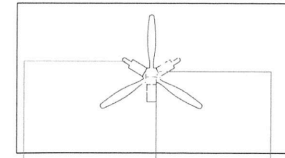

Insertion tabs are inserted and then folded
 Insertion holes
 Fold lines can be seen as shown here

Legends:

- Engraved/Color side
- Non-engraved/Silver side
- Attention point
- Insert tab and bend 90 degrees
- Insert tab and twist 90 degrees

Recommended tools:

-Wire cutters: helpful for taking parts from the metal sheets.



-Tweezers or needle nose pliers: helpful for folding parts, bending and twisting tabs.

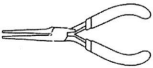

Assembly tip:

If needed, slightly twist tabs to hold parts together then untwist and bend them down for a nice finish

Assembly Flow Chart

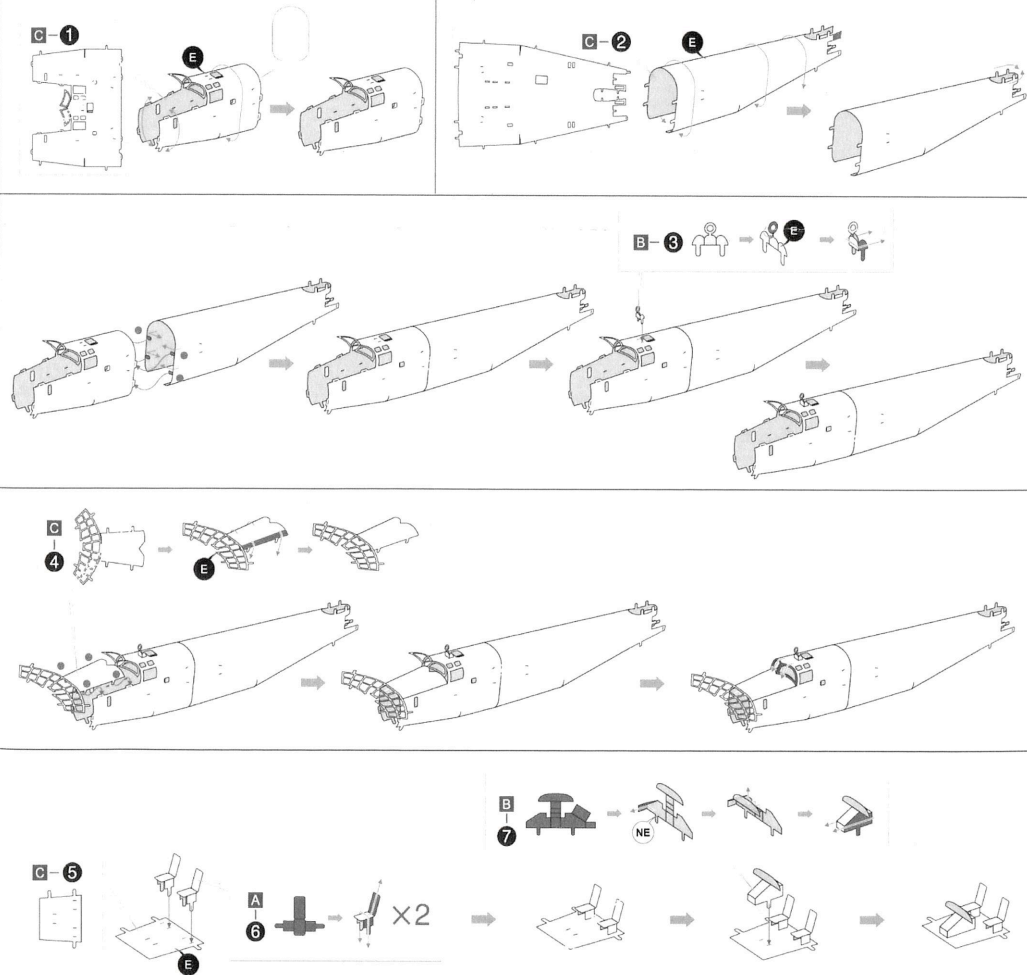

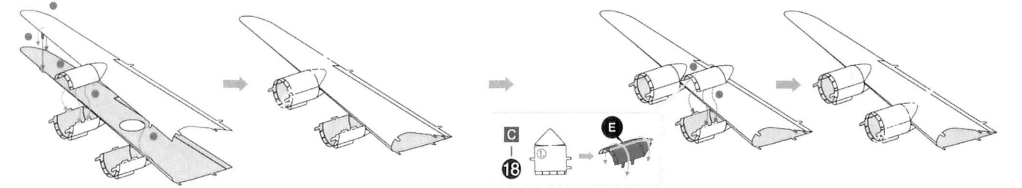
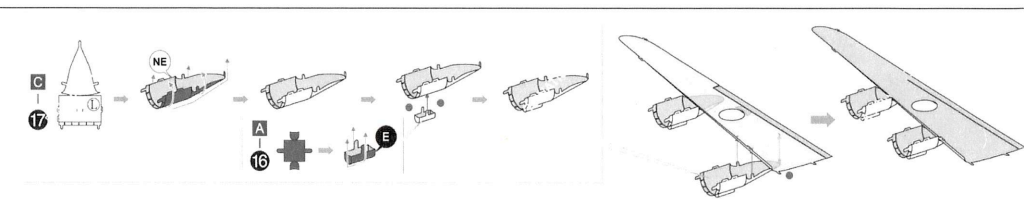
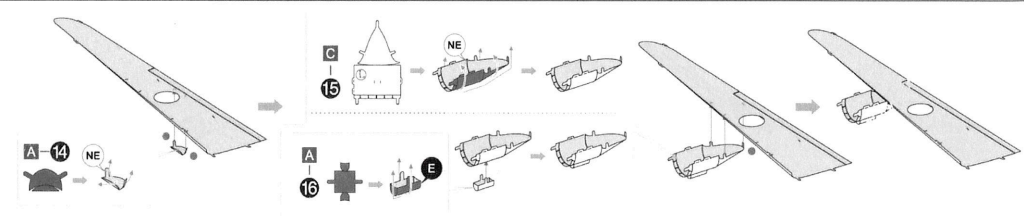
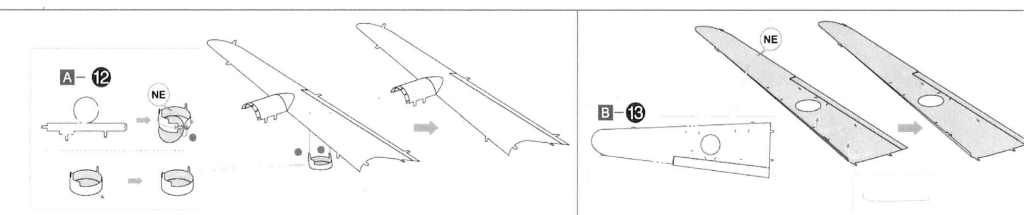
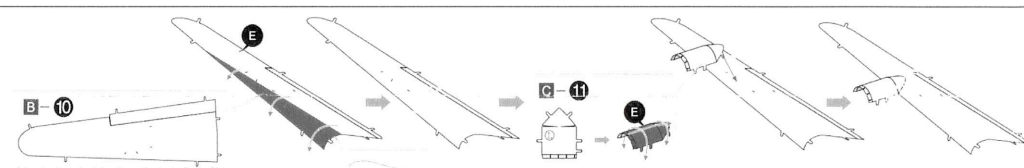
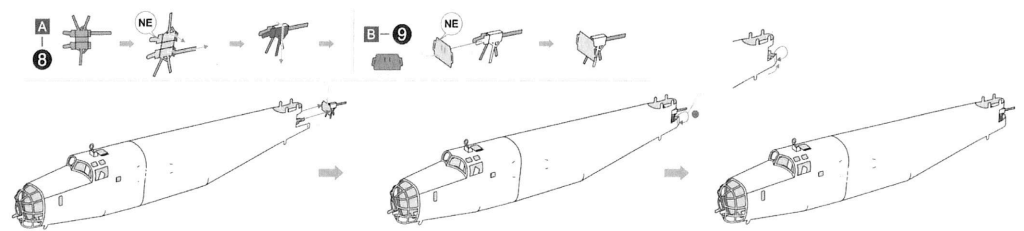
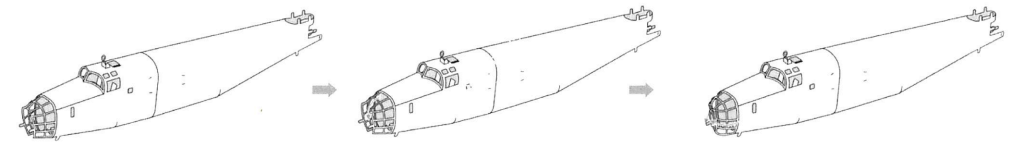
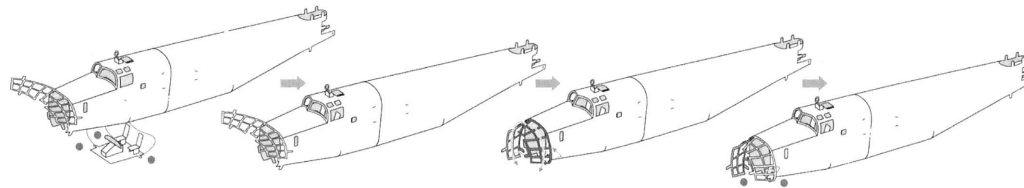

Insert the blue holes firstly, then insert the red holes.

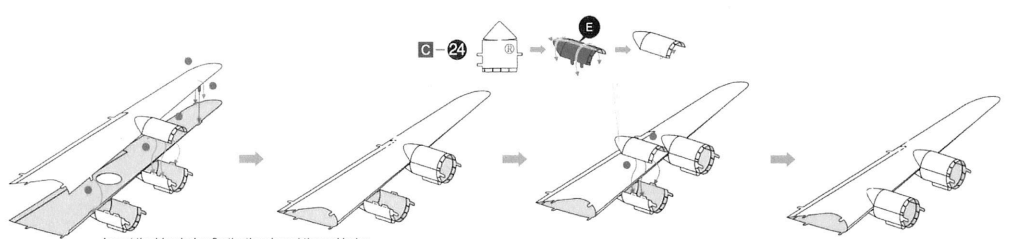
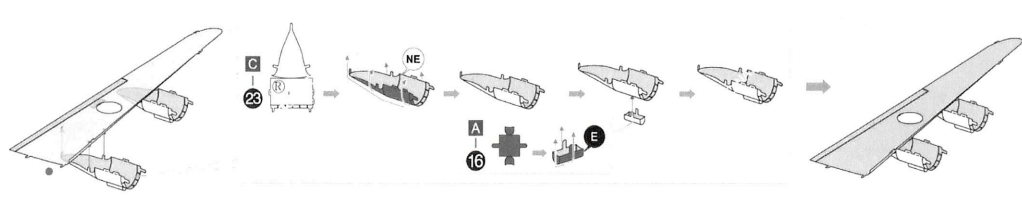
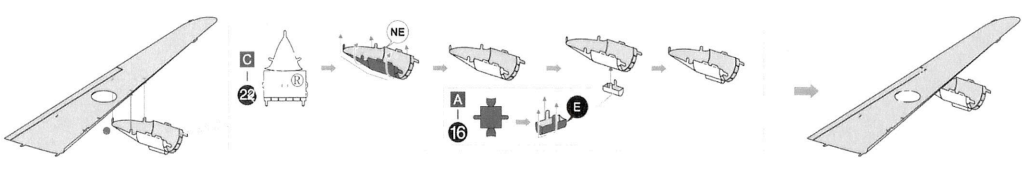
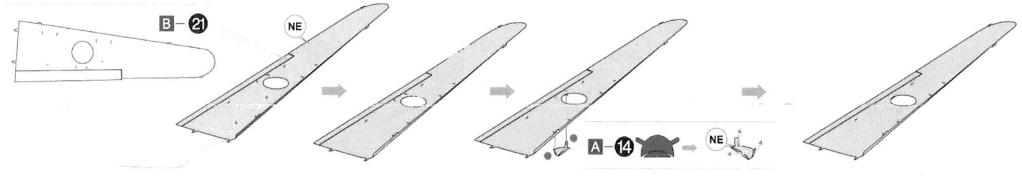
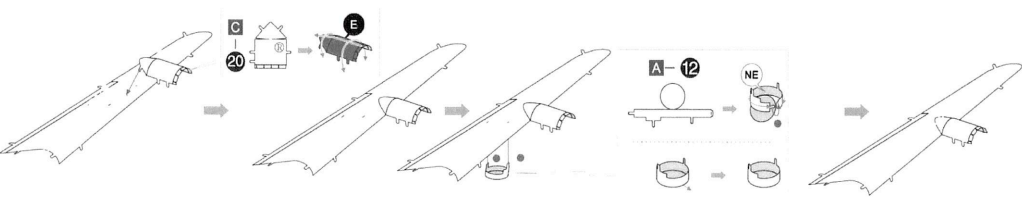
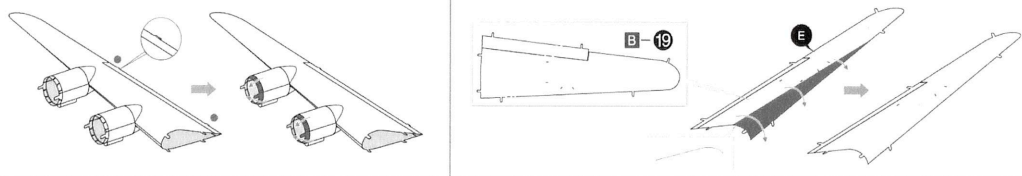

Insert the blue holes firstly, then insert the red holes.

