

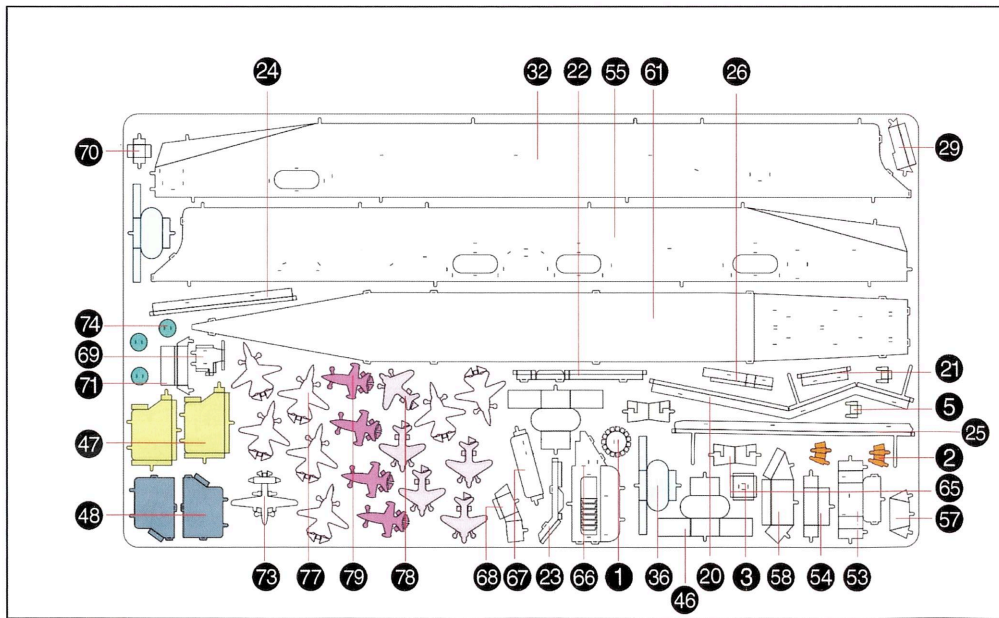

3D METAL MODEL KITS

METAL SHEETS

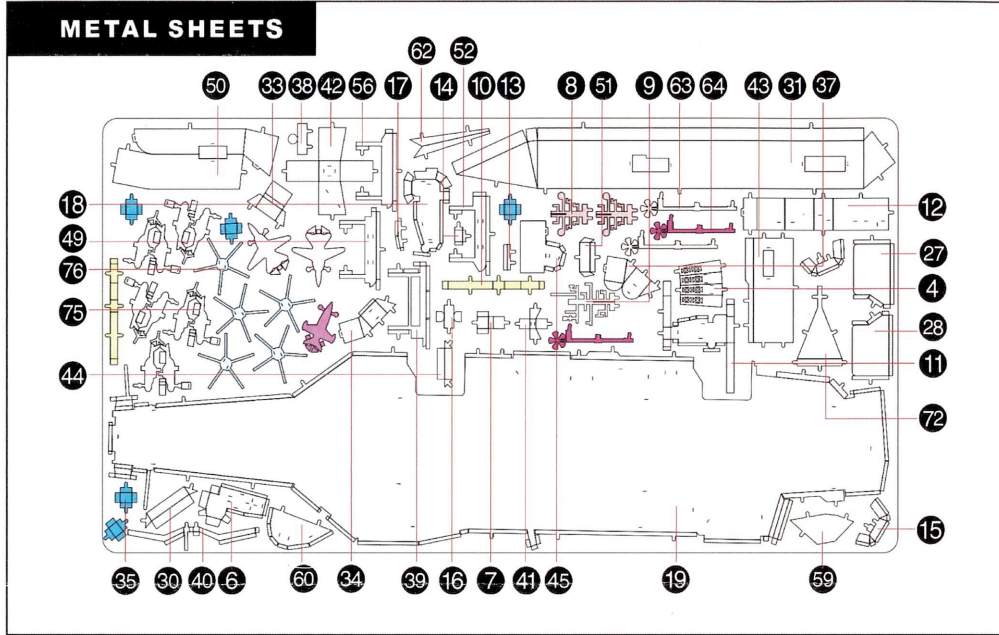

In order to avoid possible injury from sharp edges, please carefully



ICX022

USS Theodore Roosevelt Carrier

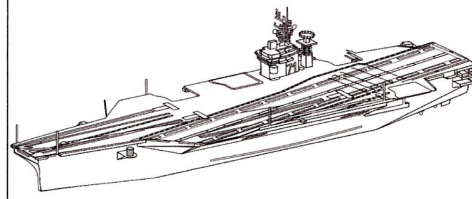

TO CREATE THE BEST CONNECTIONS

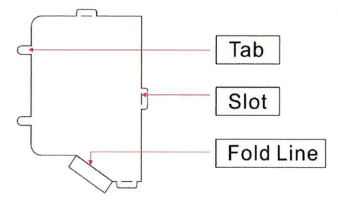

Legends:

- Engraved side
- Non-engraved side
- Attention point
- Insert tab and bend 90 degrees
- Insert tab and twist 90 degrees

Recommended tools:

- Wire cutters: helpful for taking parts from the metal sheets.
- Tweezers or needle nose pliers: helpful for folding parts, bending and twisting tabs.

Assembly tip:

If needed, slightly twist tabs to hold parts together then untwist and bend them down for a nice finish

ASSEMBLY STEPS

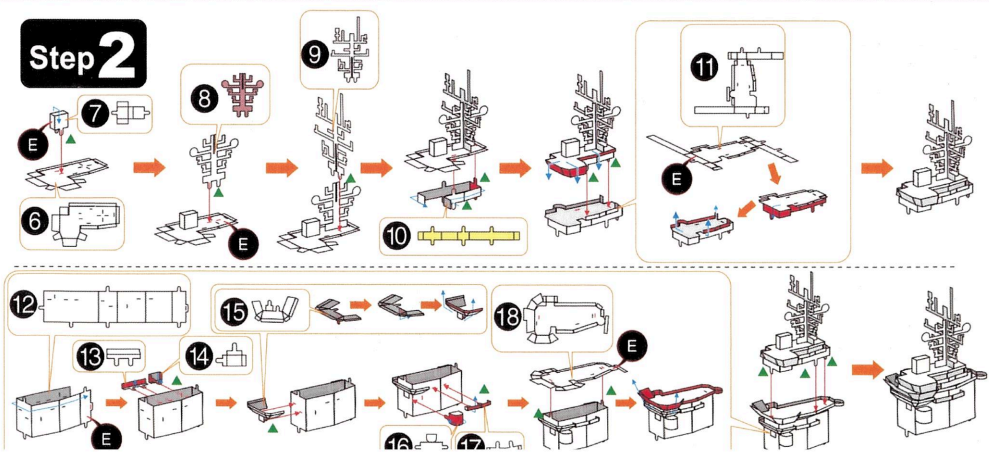
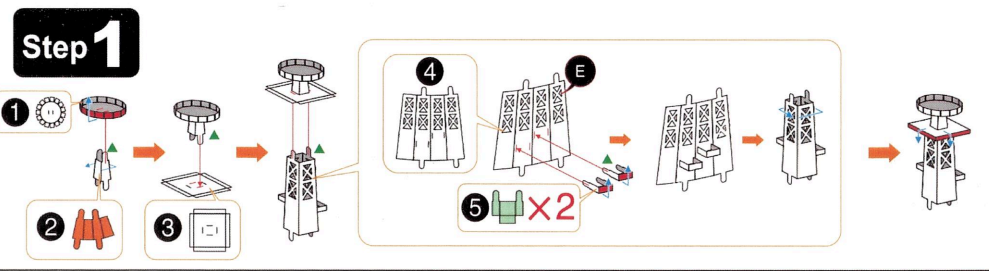

Step 3

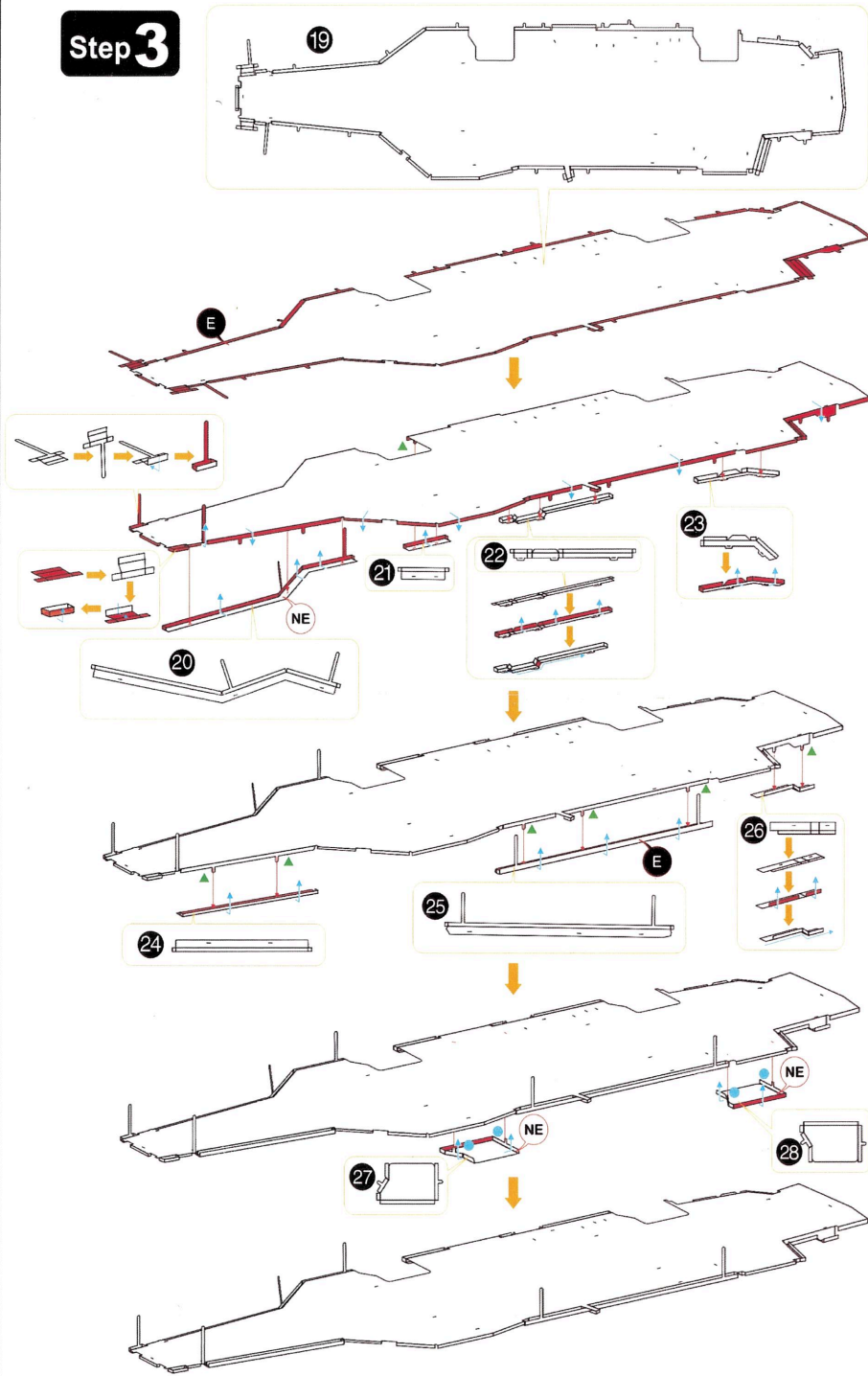

Step 4

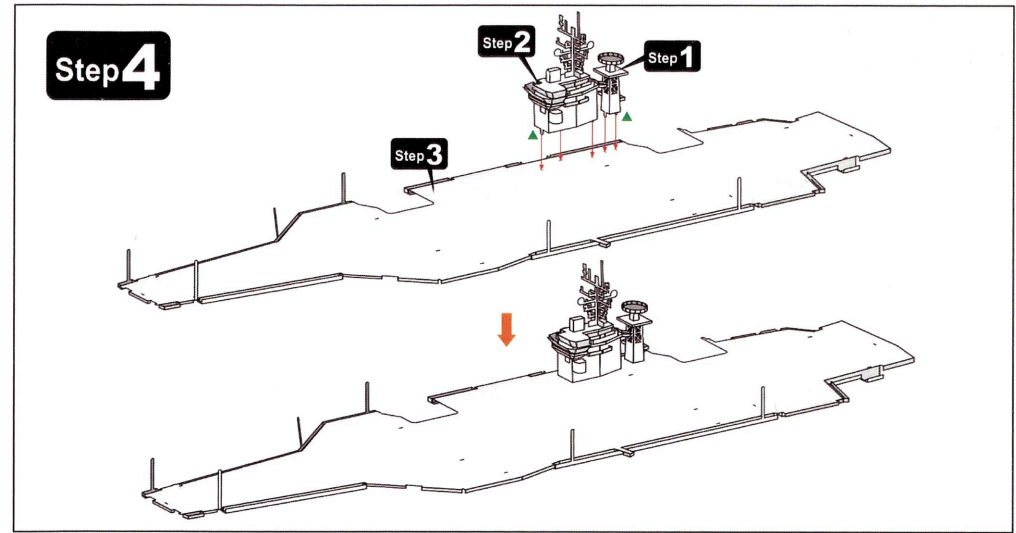

Step 5

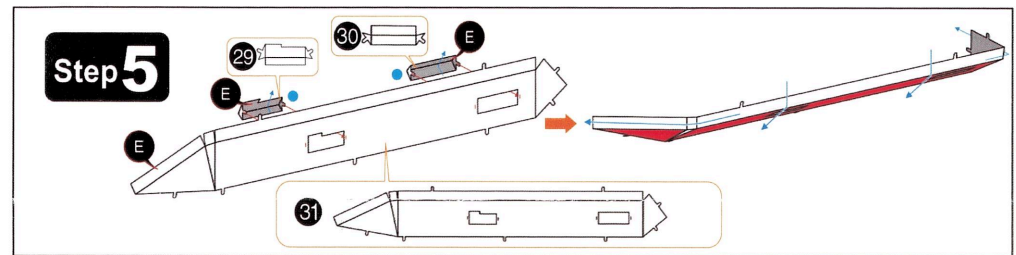

Step 6

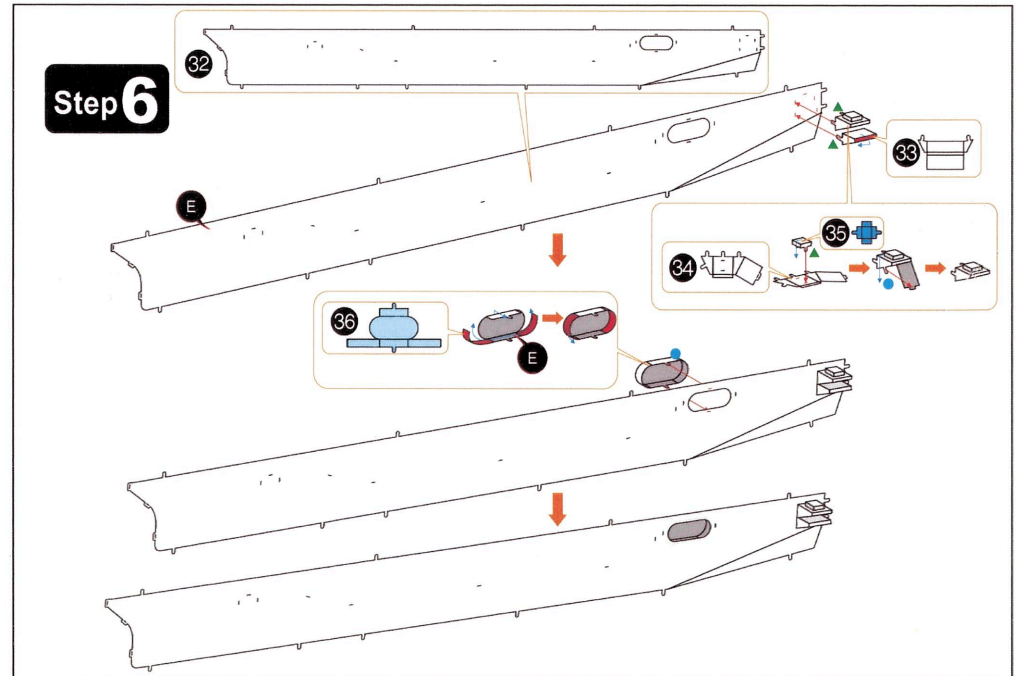

Step 7

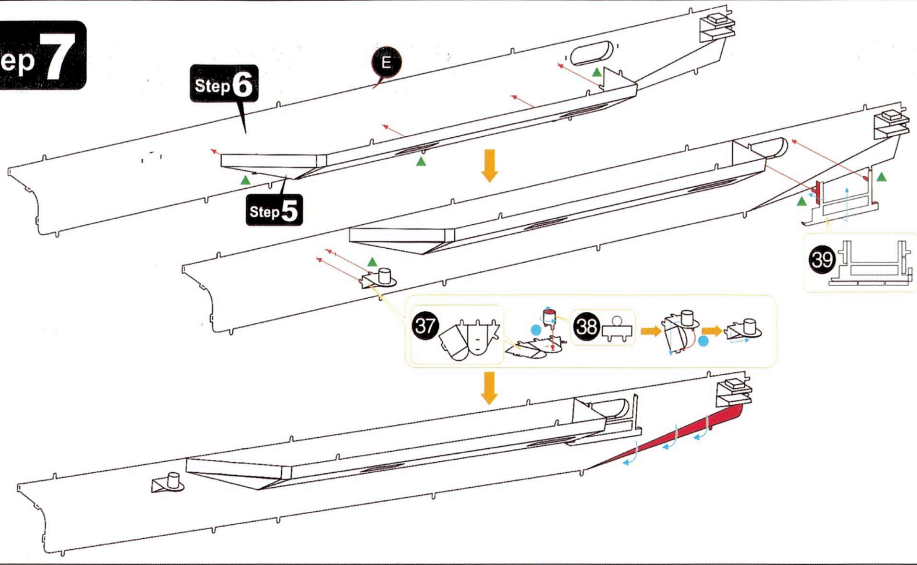

Step 8

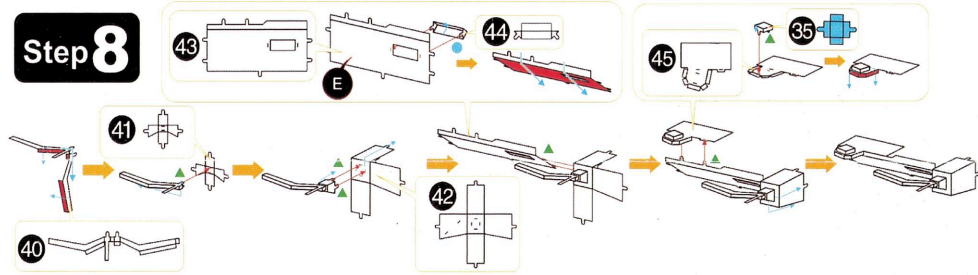

Step 9



Step 10

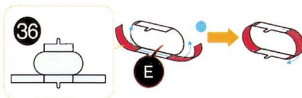

Step 11

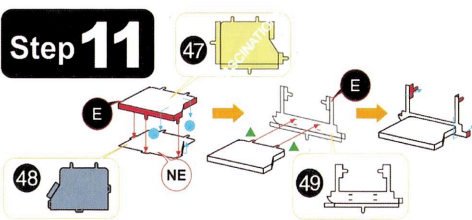

Step 12

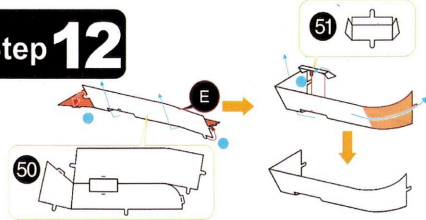

Step 13

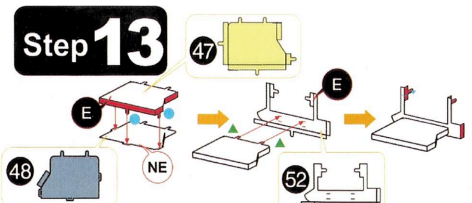

Step 14

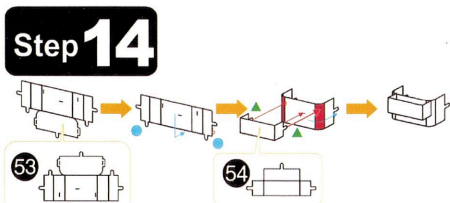

Step 15

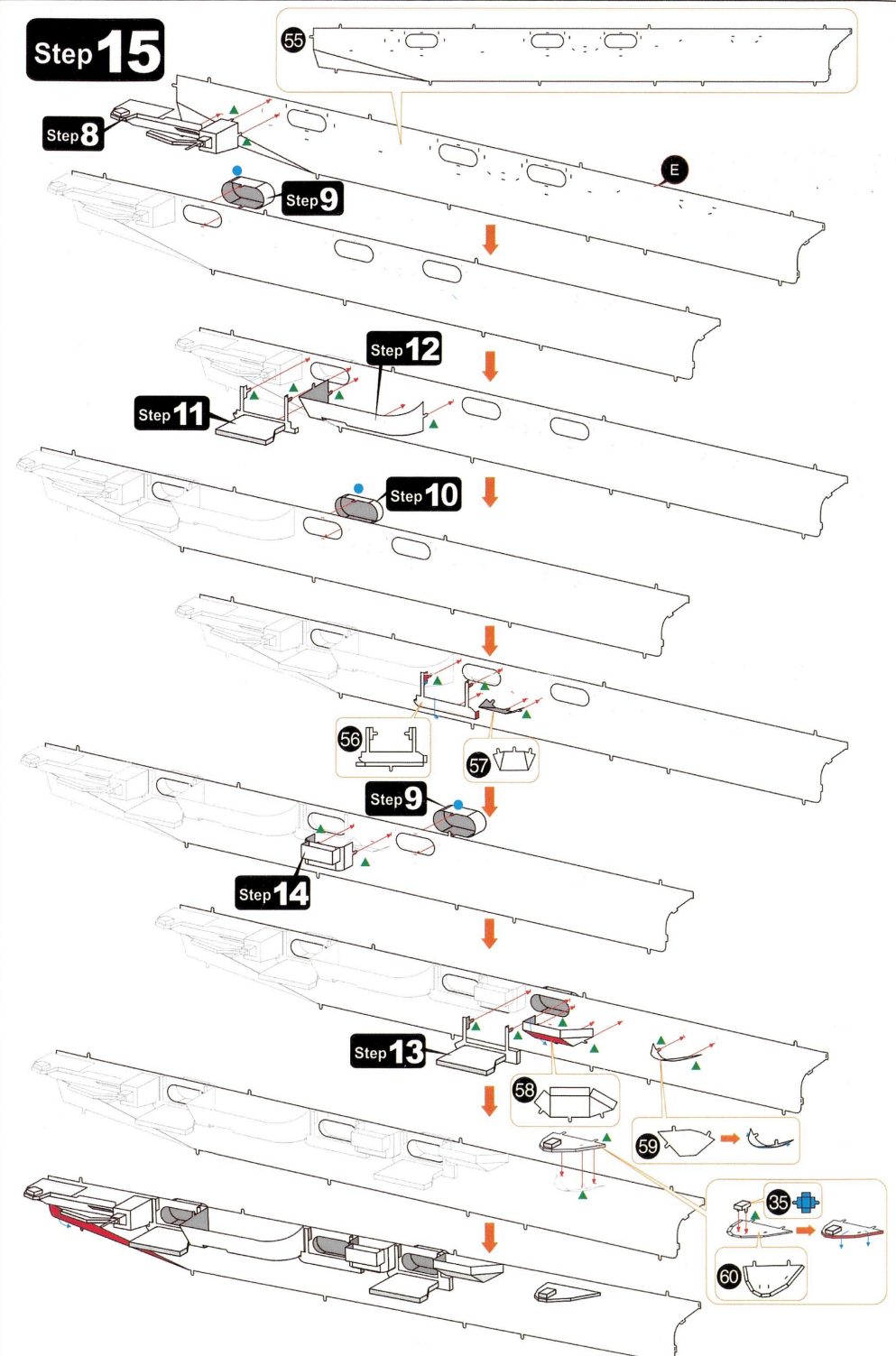

Step 16

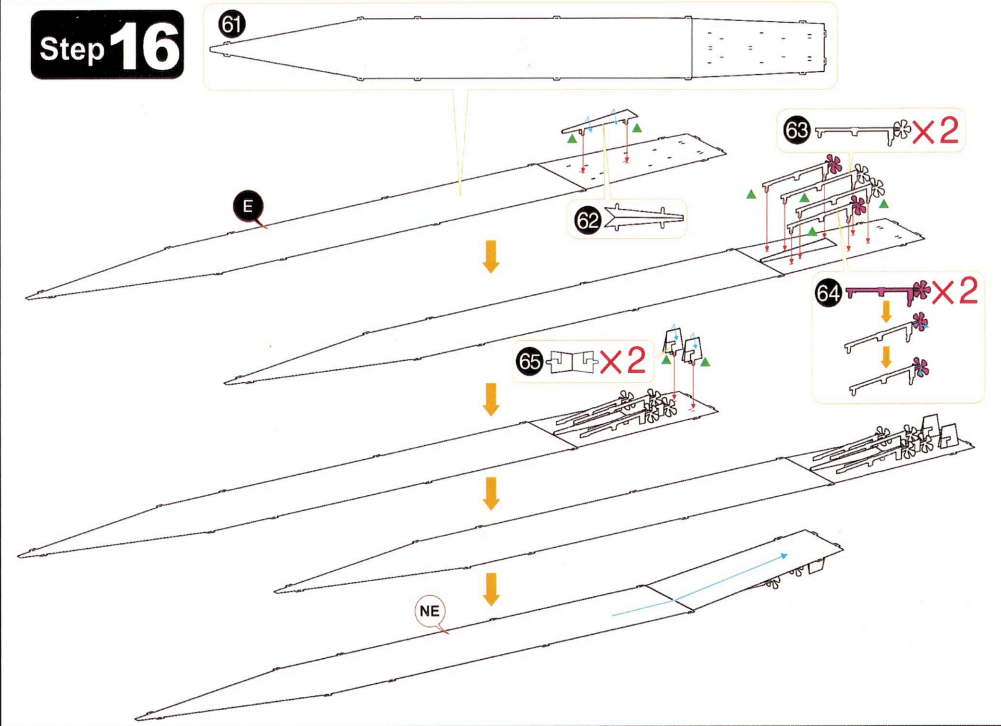

Step 17

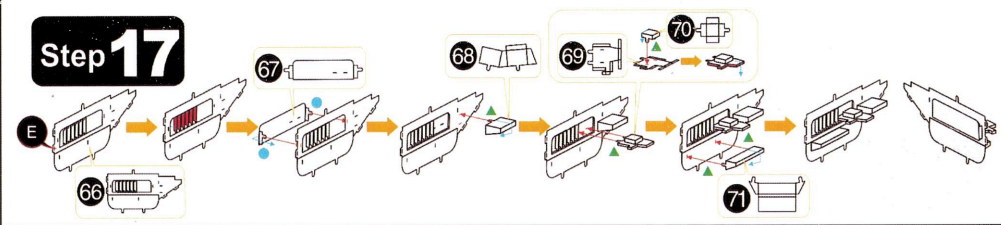

Step 18

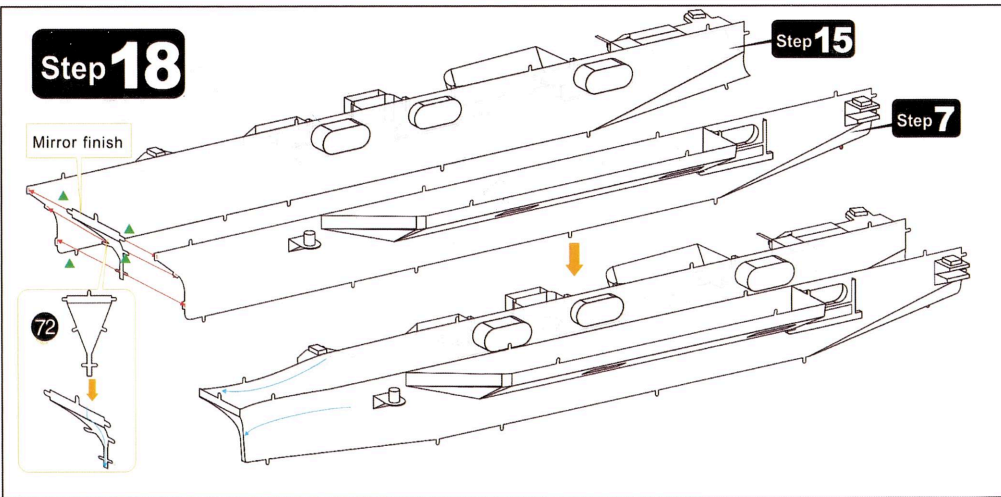

Step 19

