



1/48 SCALE MODEL CONSTRUCTION KIT



# Caudron C.635 Simoun

DW 48030

## COLOR TABLE

Color Chart	MR. HOBBY	Tamiya	AMMO MIG	Hataka	LIFECOLOR
Black	<b>A</b> C33/H12	XF-1	MIG 046	HTK 100	LC 02
Silver	<b>B</b> C8/H8	X-32	MIG 195	HTK B003	LC 74
Aluminium	<b>C</b> MC 218	XF-16	MIG 194	HTK 078	LC 24
Gun Metal	<b>D</b> C78/H28	X-10	MIG 045	HTK 106	LC 26
Rubber Black	<b>E</b> C137/H77	XF-85	MIG 035		UA 733
Tan	<b>F</b> C44/H27	XF-55	MIG 202	HTK 187	LC 15
Clear Red	<b>G</b> C47/H90	XF-27	MIG 093		
Clear Green	<b>H</b> C138/H94	XF-25	MIG 092		
Burnt Iron	<b>I</b> C61/H76	XF-25	MIG 187		LC 37
Red	<b>J</b> C327/H327	XF-2	MIG 049	HTK-103	LC 56
Brun Fonce	<b>K</b> H84/H17 (50:50)	XF-52+ XF-10+XF-2 (5:5:1)		C 079	UA 143
Grís Bleu Fonce	<b>L</b> H56/H11 (50:50)	XF-53+ XF-2 (5:2)		C 082	UA 141
Grís Bleu Clair	<b>M</b> H67/H11 (50:50)	XF-23+ XF-2 5:2		C 083	UA 145
Bleu Nuit Interieur	<b>N</b> C366/H56	XF-18	MIG 228	HTK 027	UA 45
White	<b>O</b> C62/H11	XF-2	MIG 0047	HTK 101	LC 01
Khaki Français	<b>P</b> H80/H11(70:30)			C 084	UA 142



## USED SYMBOLS



CEMENT



DON'T CEMENT



REMOVE



ASYMMETRICAL



x2



BEND



OPEN WHOLE



VARIANTS



TO PAINT

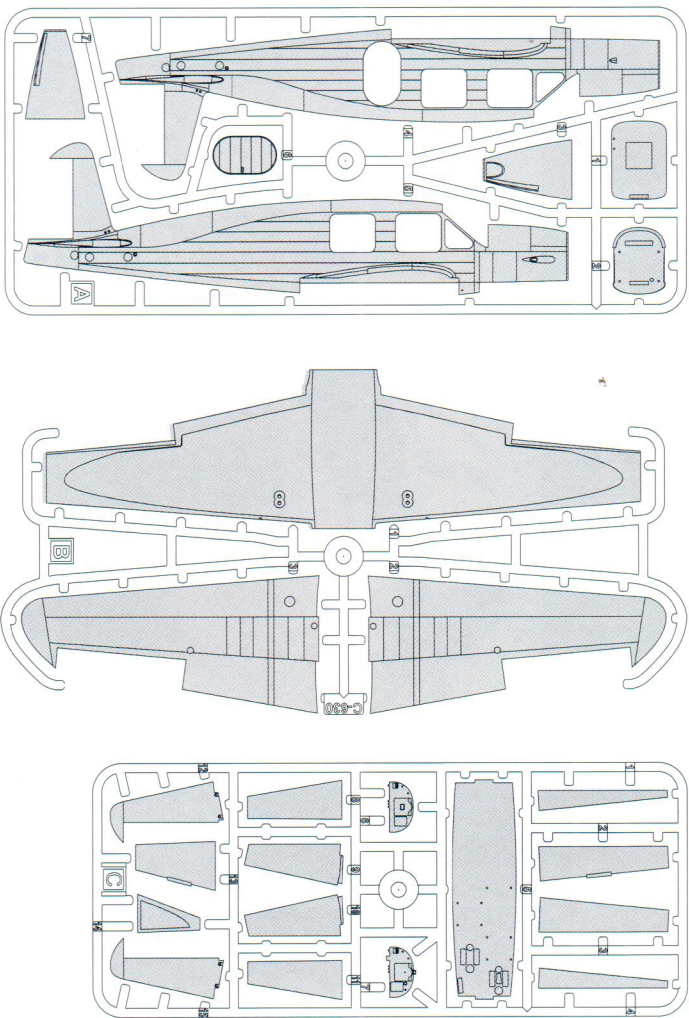

PE

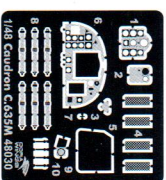

Decal

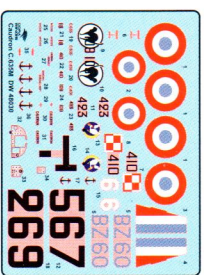
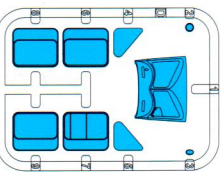

11

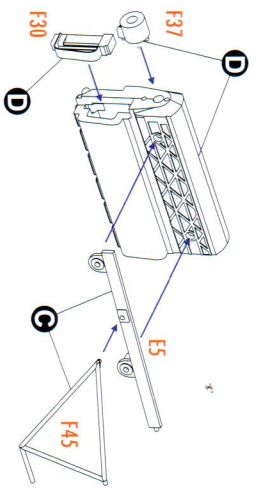

12

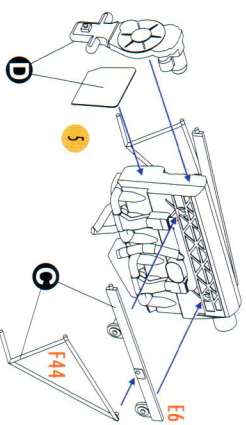

13



14

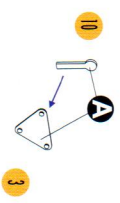

15

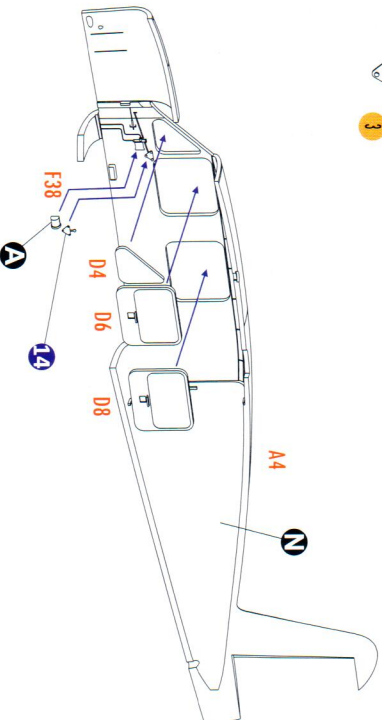

16

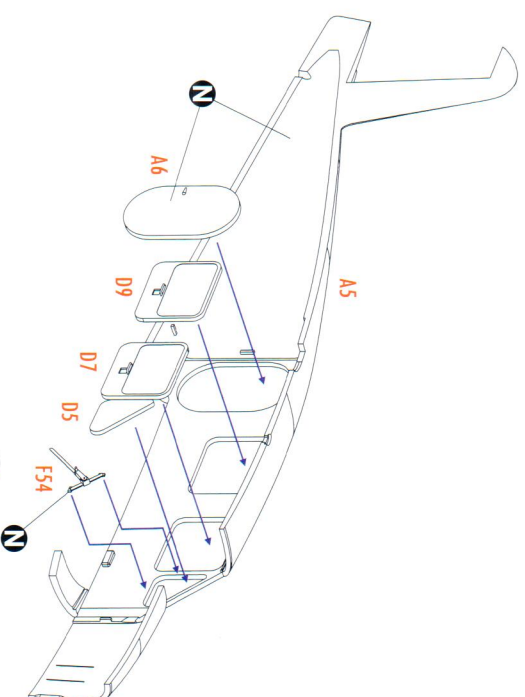

17

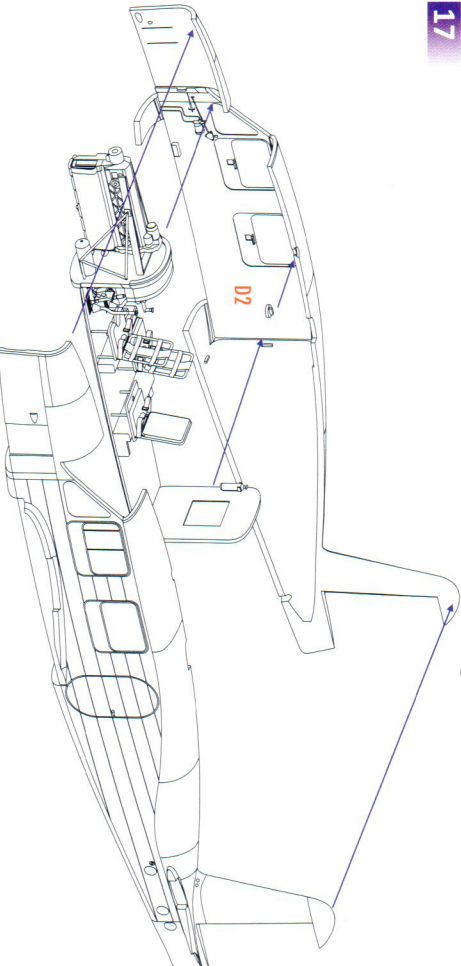

18

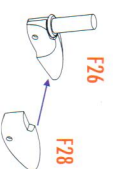

19

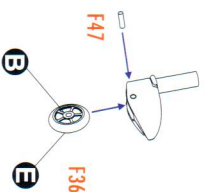

20

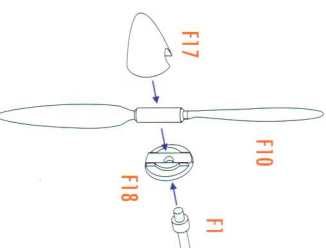

21

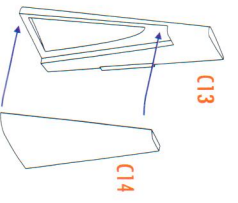

22

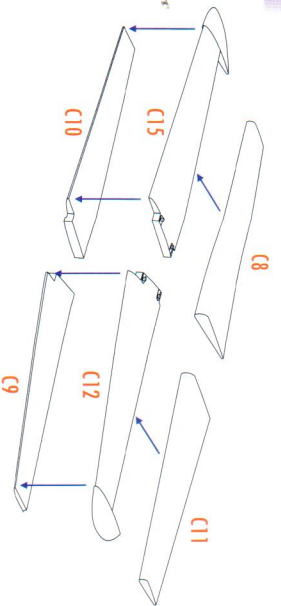

23

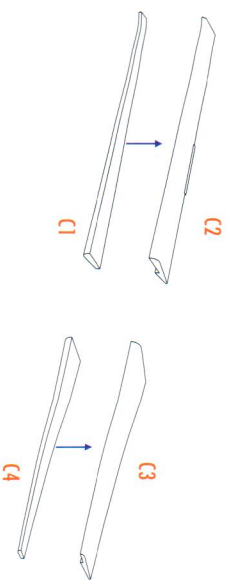

24

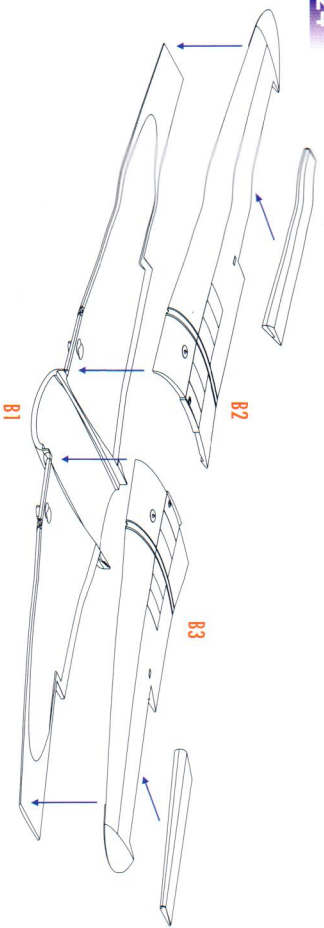

25

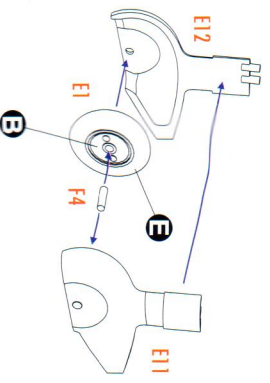

26

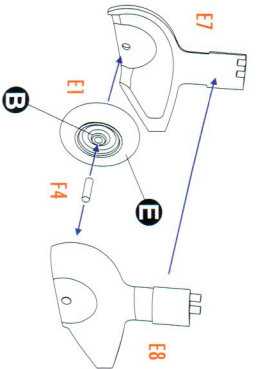

27

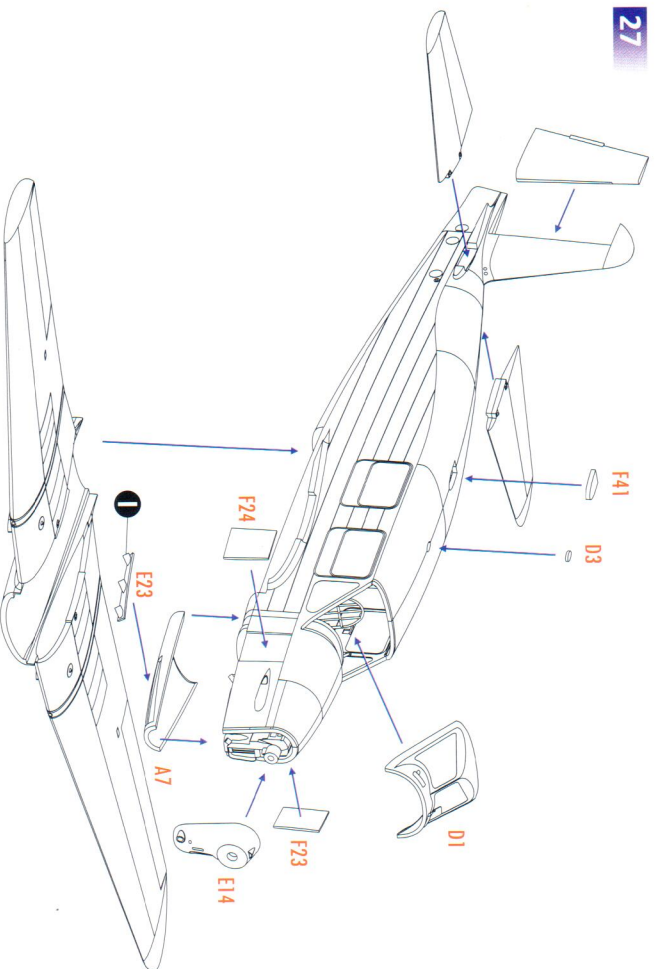

28

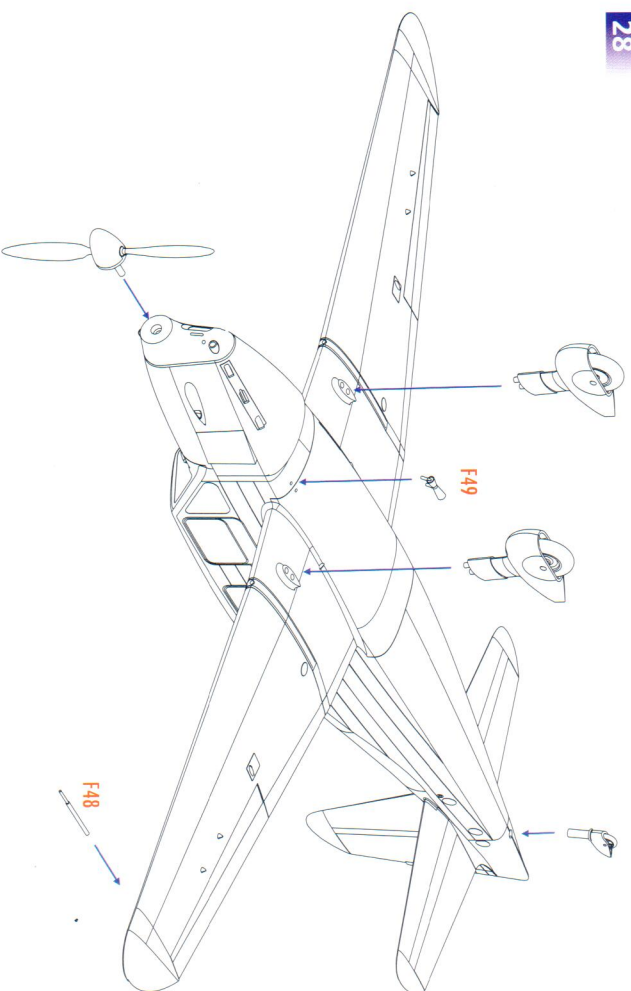

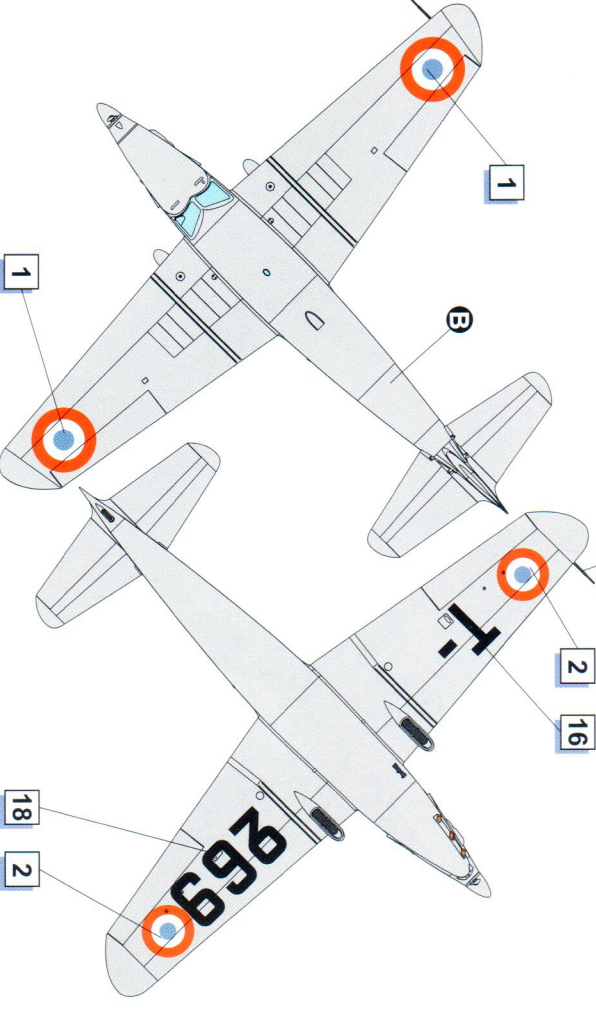
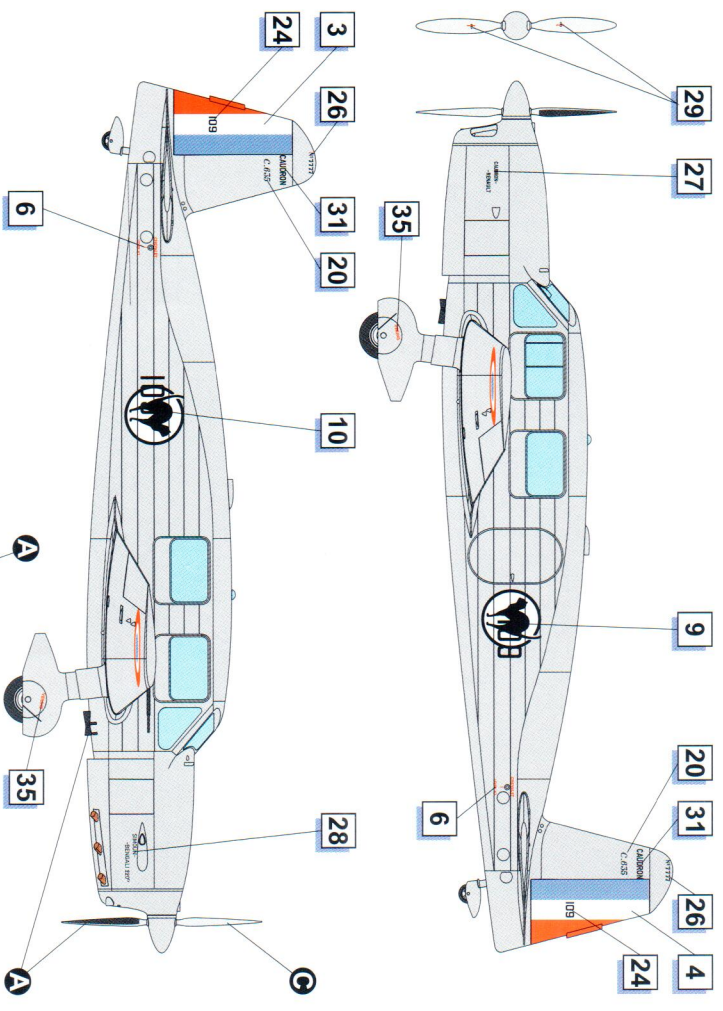
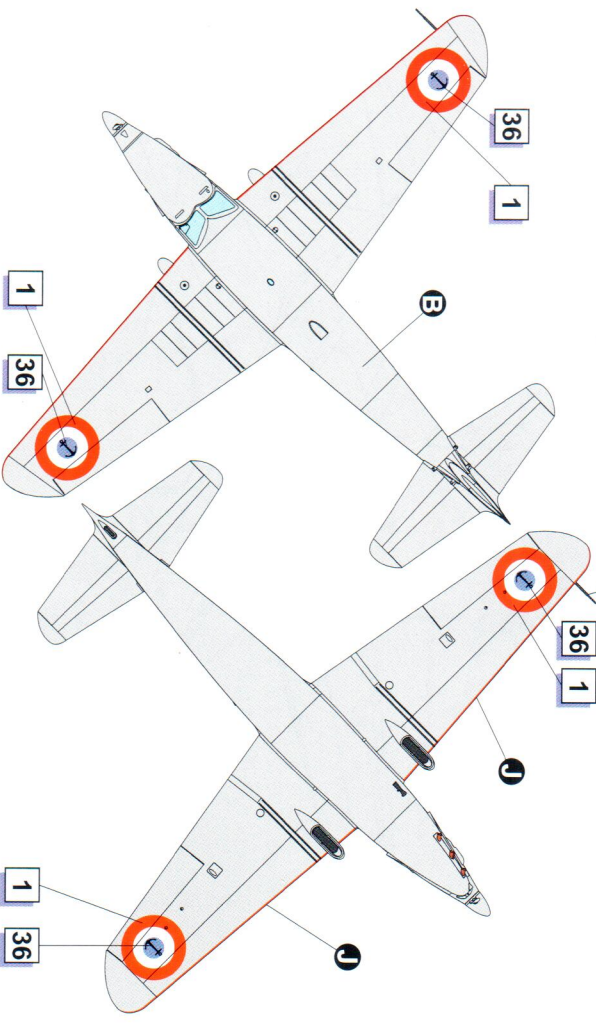
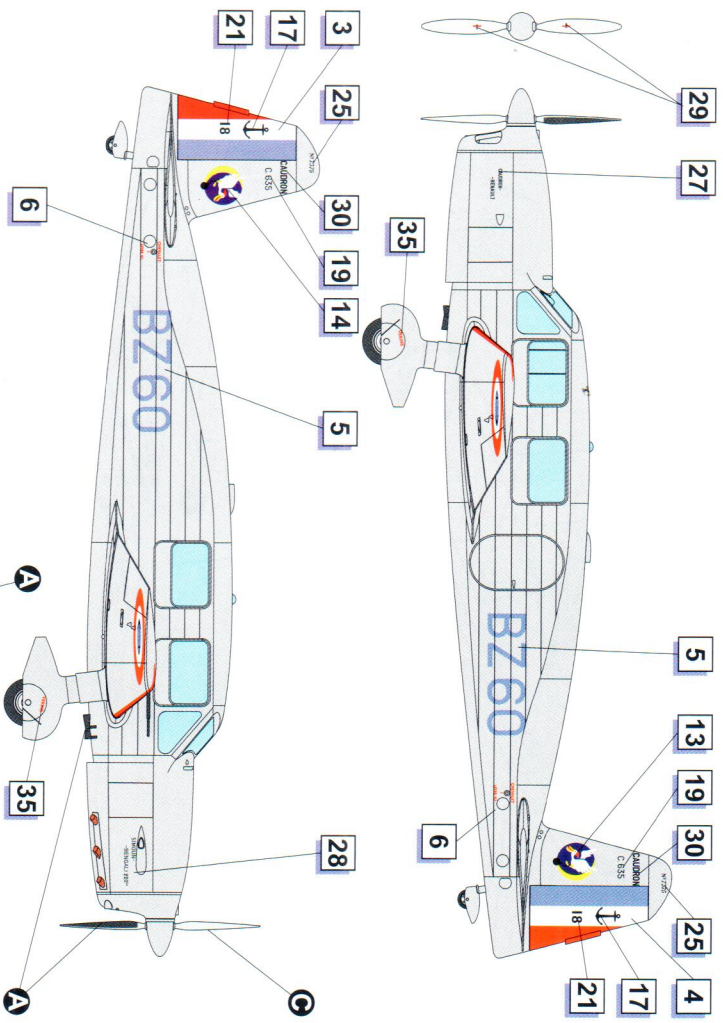

Caudron C635M BZ60, base di Sidi Ahmed, Tunisia, 1939

Caudron C635M №423, Melun-Villaroche Flight School, March 1940

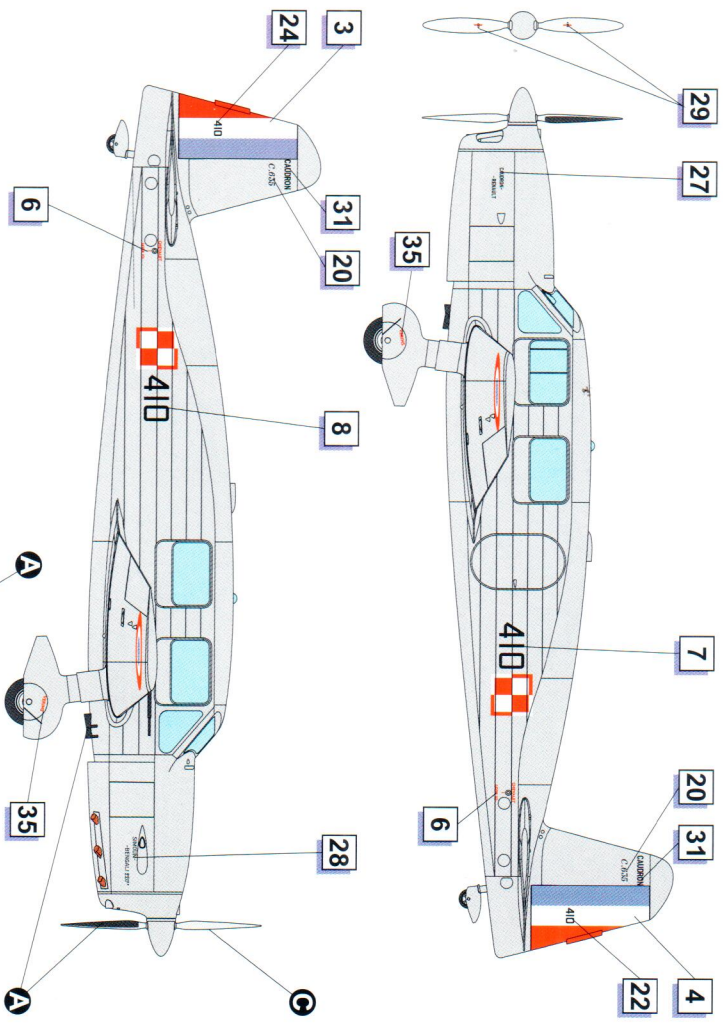

Caudron C635 №109, Division d'Instruction Dugny-Le Bourget, 1939

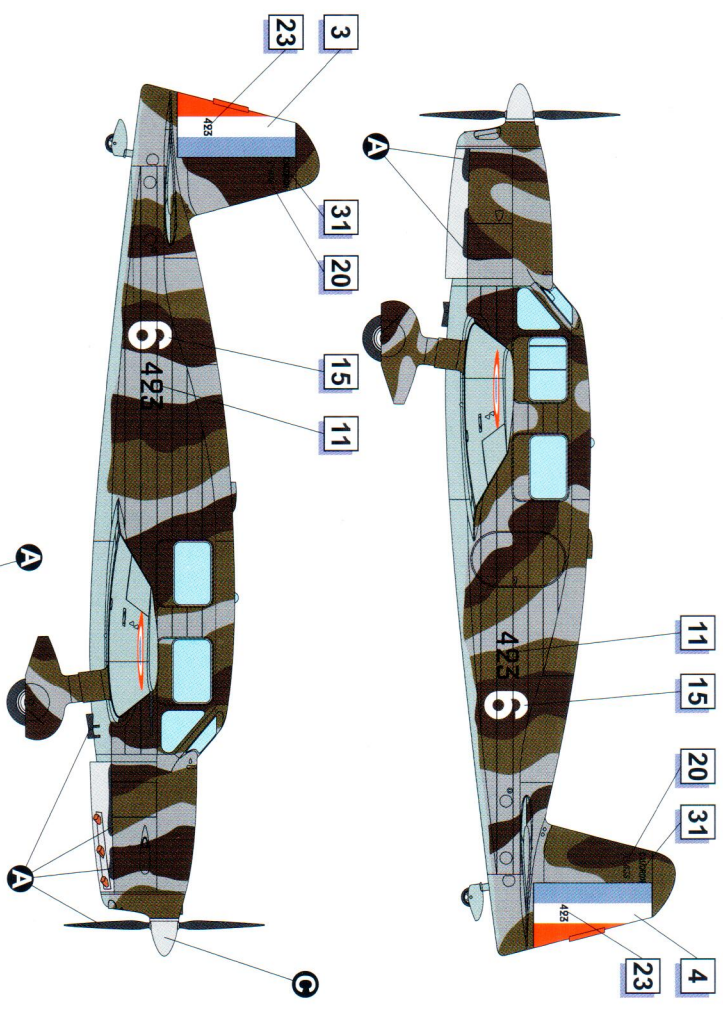
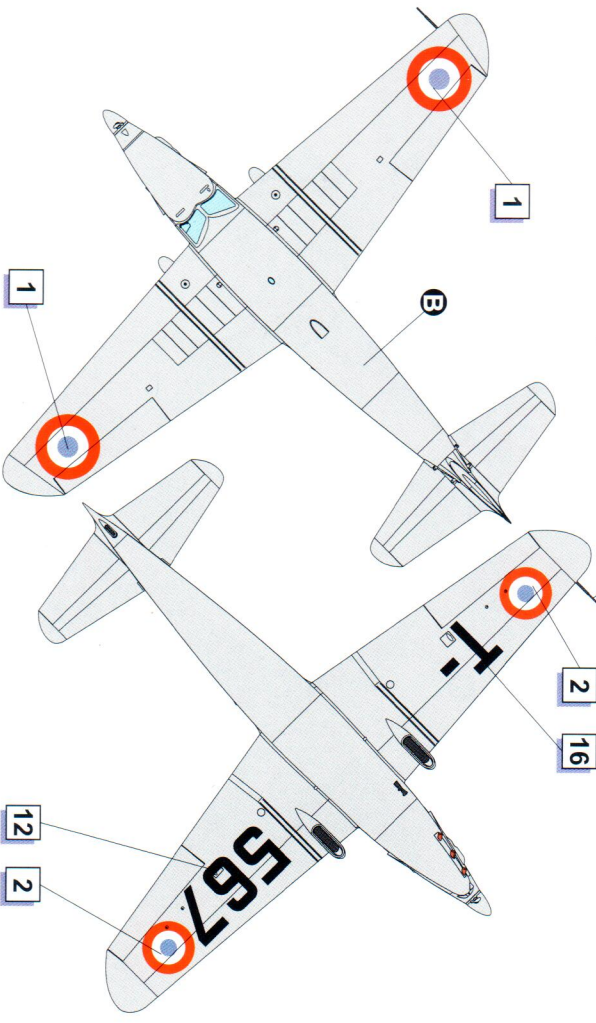

Caudron C635 №410, DIAP Lyon-Bron, 1940

