

# 3D METAL MODEL

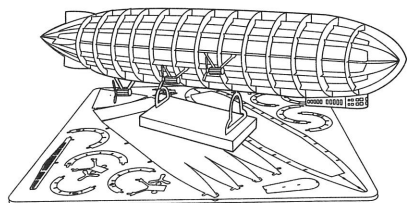

3DJS050

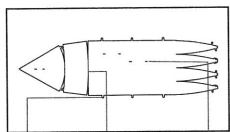

扣点 折线 扣孔



拼装工具

## 拼装方式

● 插入扣孔，平折 90°

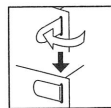

▲ 插入扣孔，旋转 90°

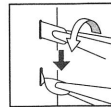

## 金属部件

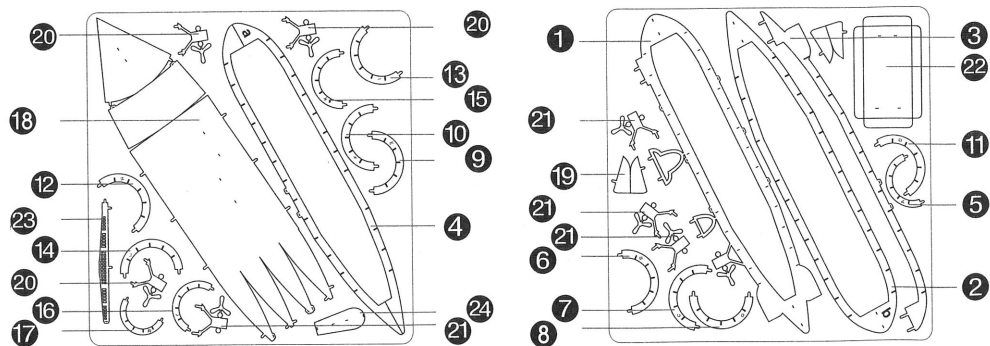

## 拼装步骤

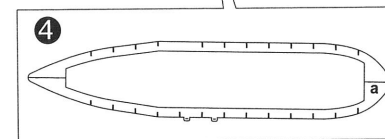
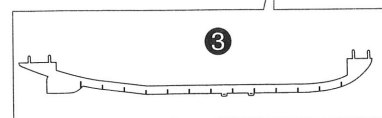
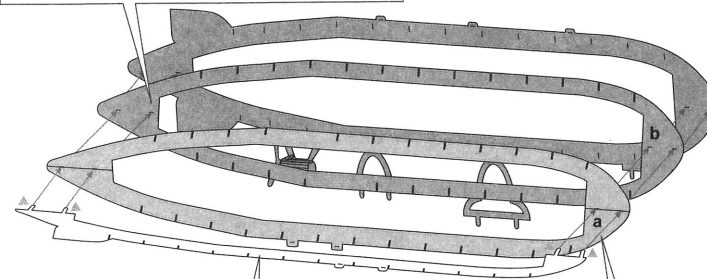
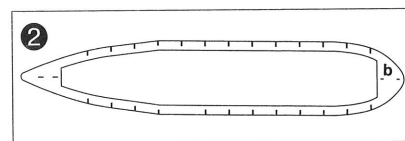
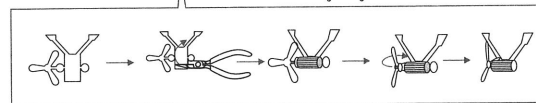
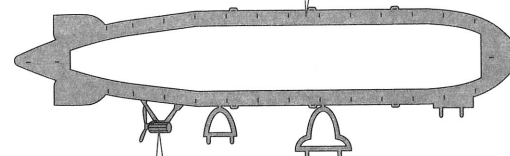
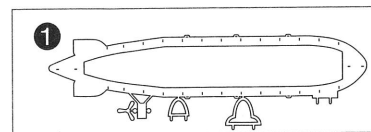

⚠ 请小心处理金属边料，以防划伤

